

ENTRUST

Sigma DS4 and DS4-ES1 Instant Issuance System Quick Install Guide



Do not continue unpacking this box until you have read these instructions.



Read and follow these instructions to set up your Sigma printer.

1

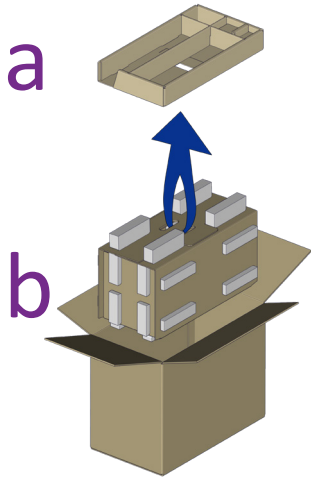

d

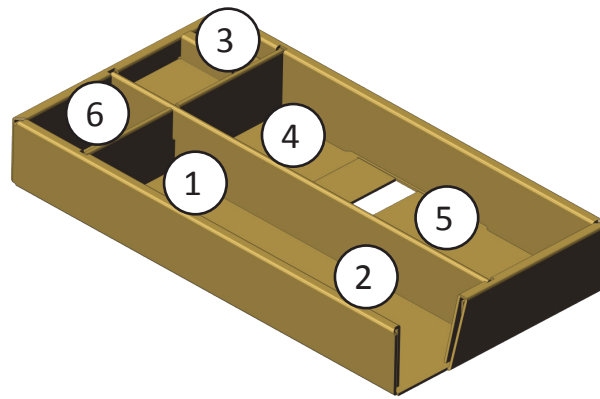

- 1 Power supply
- 2 Power cord
- 3 USB flash drive
- 4 USB cable
- 5 Cleaning swabs
- 6 Keys

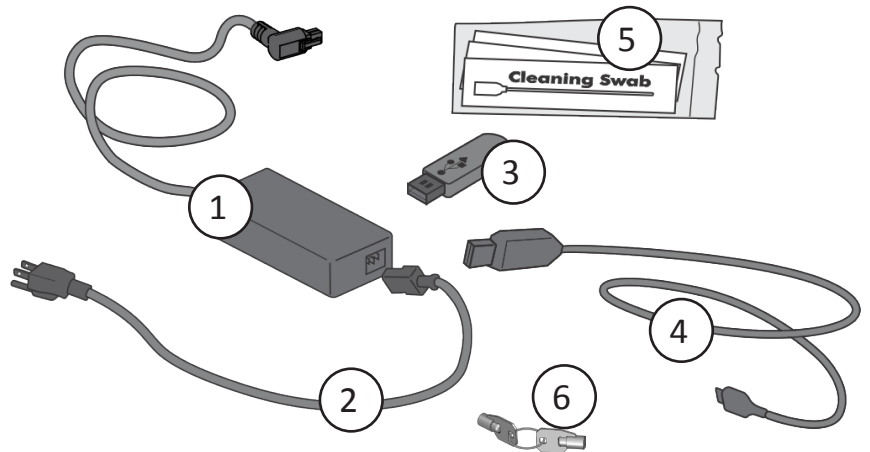
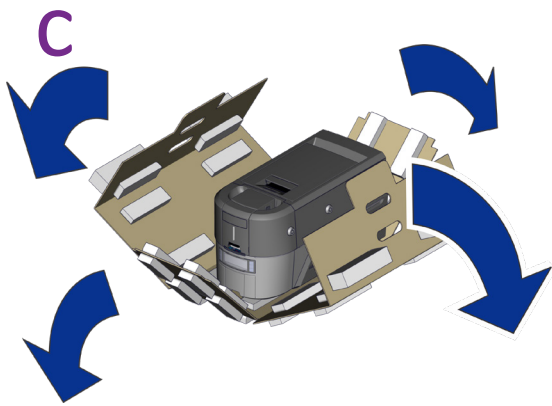

The keys unlock the printer and input hopper

2

Refer to your ribbon supply box to prepare the ribbon.

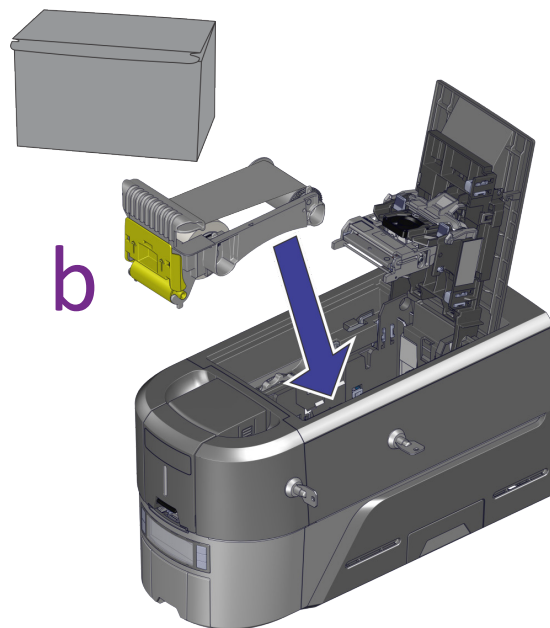
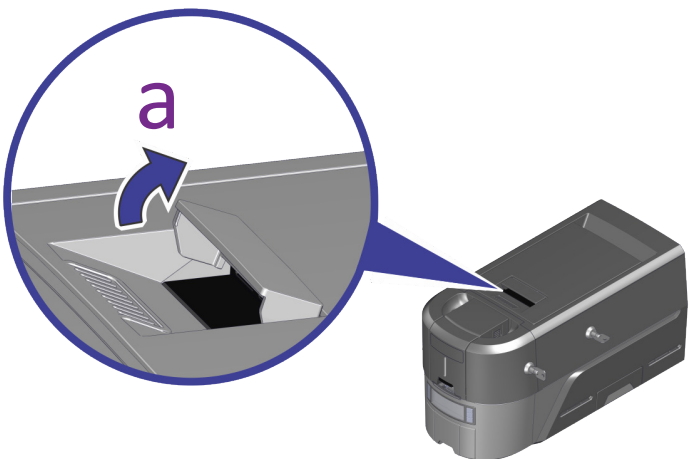

3

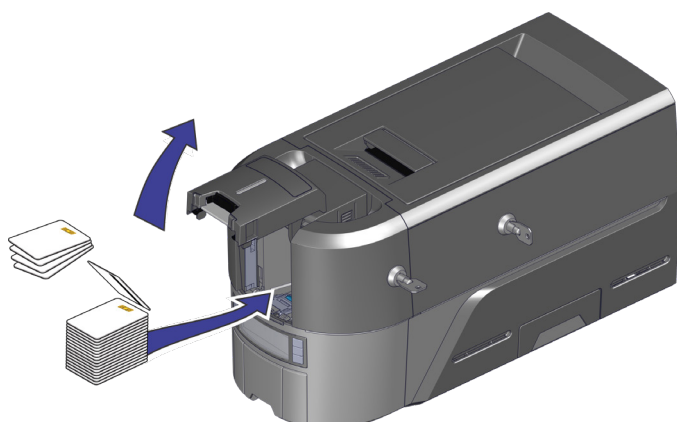

Continued

4

Refer to the Upgrade Kit instructions if you plan to add an embosser to the system.

5

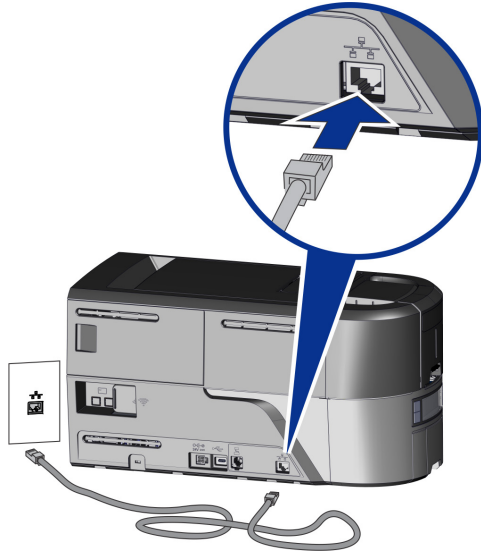

6

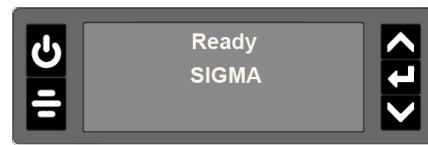
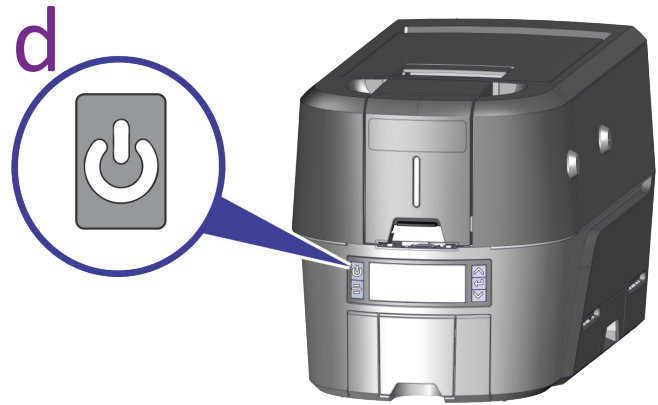
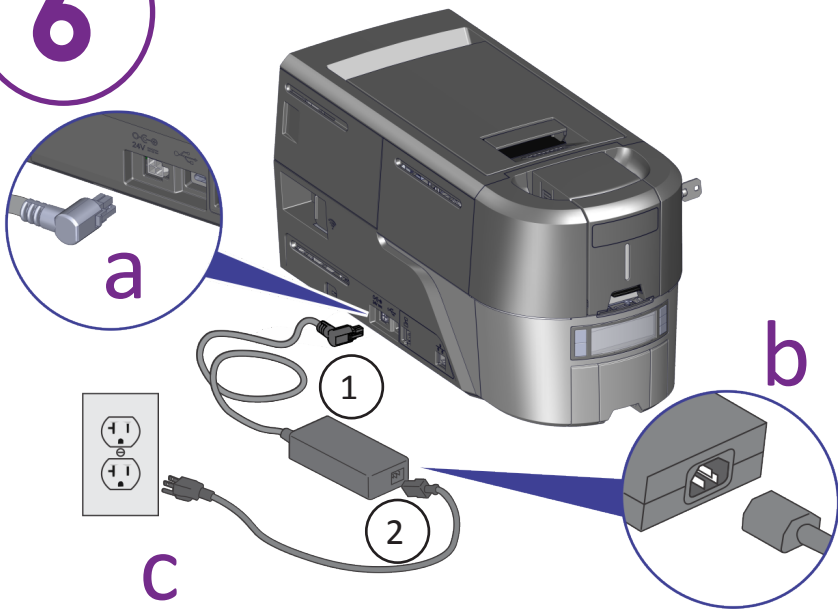

7

Set a Static IP Address.

a

IP Address _____

Subnet Mask _____

Gateway Address _____

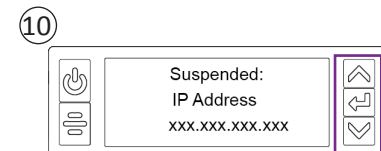
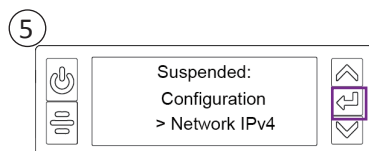
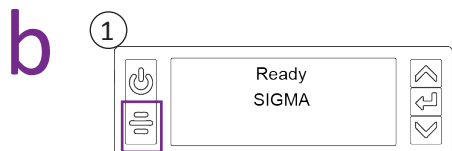
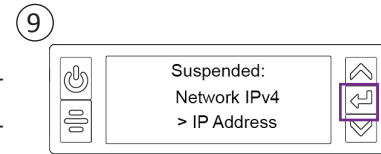

Use the arrow keys to change the right-most digit one number at a time. Press Enter to save each value and continue to the next section of the address. Press Enter when all four sections are correct.

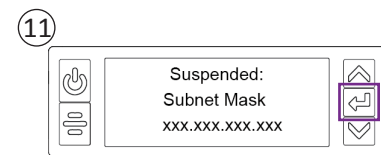
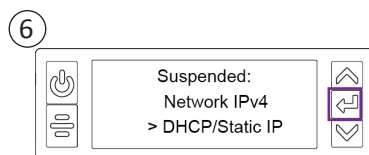
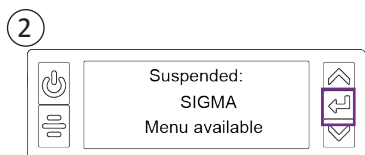

Repeat step 10 to enter the subnet mask.

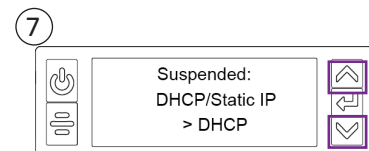
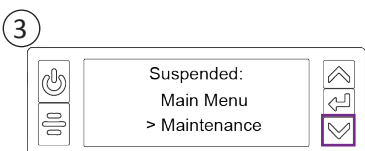

Repeat step 10 to enter the gateway address

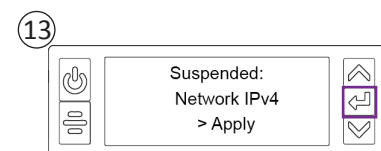
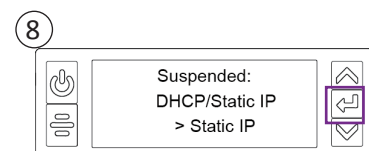
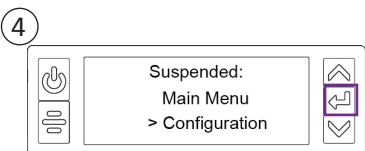

Press Enter when you finish entering the address information. Press Enter to apply your changes.

c Power off and restart the printer to verify that the static IP address is correct.

8

Complete the Installation.

- Refer to the printer's *Installation and Administrator's Guide* for complete installation instructions.
- Define the printer to CardWizard Administrator. Refer to the *CardWizard Issuance Software and Card Printer Setup Guide*.
- Refer to your CardWizard documentation for complete information about using CardWizard software.

WARNING: This product contains chemicals, including lead, known to the State of California to cause cancer, and birth defects or other reproductive harm. *Wash hands after handling.*

WARNING: This product can expose you to chemicals including Di(2-ethylhexyl)phthalate (DEHP), which is known to the State of California to cause cancer, and Di(2-ethylhexyl)phthalate (DEHP) and Butyl benzyl phthalate (BBP), which are known to the State of California to cause birth defects or other reproductive harm. For more information, go to www.P65Warnings.ca.gov and www.datacard.com/califpropwarning.